

Janela/Sacada correr 2 folhas

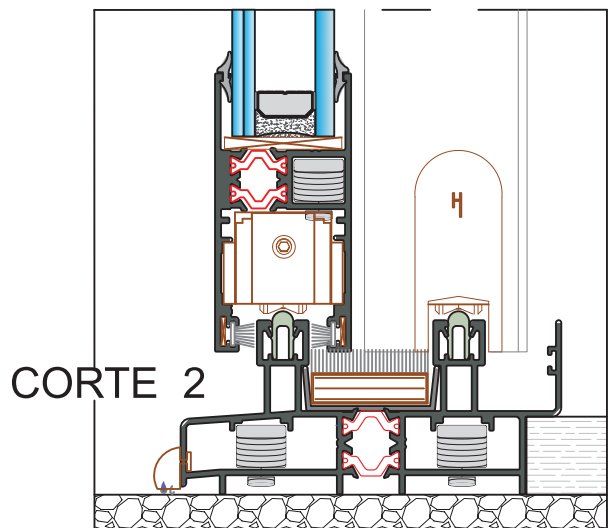

Escala
1/2

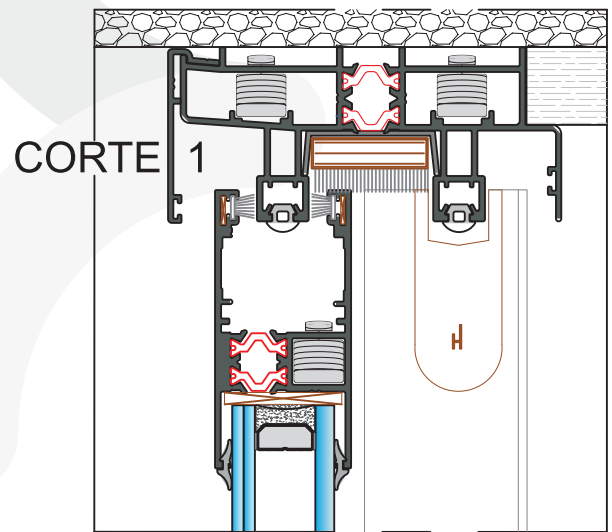
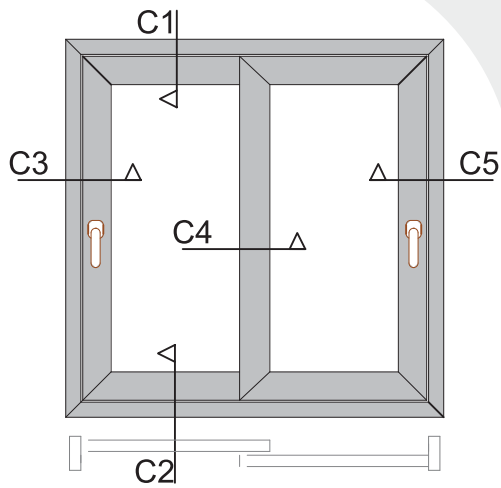
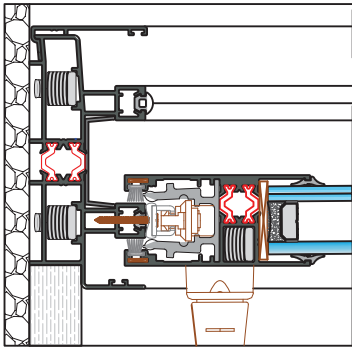

CORTE 8

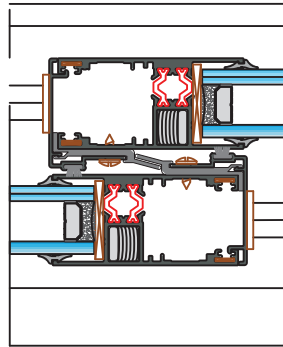

CORTE 9

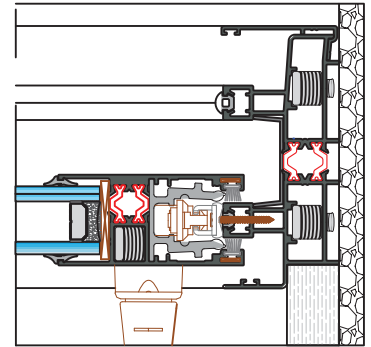
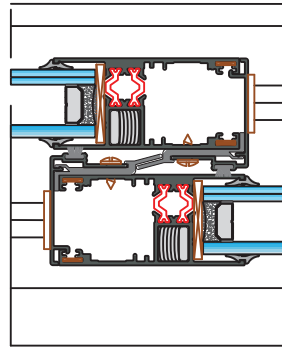

CORTE 10

Janela / Sacada correr 3 folhas

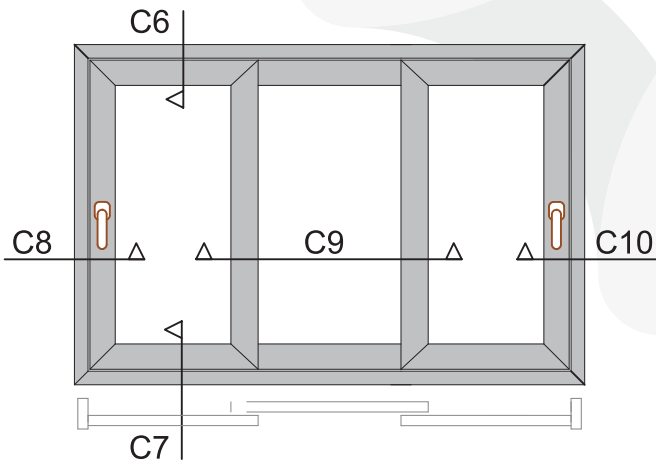

CORTE 6

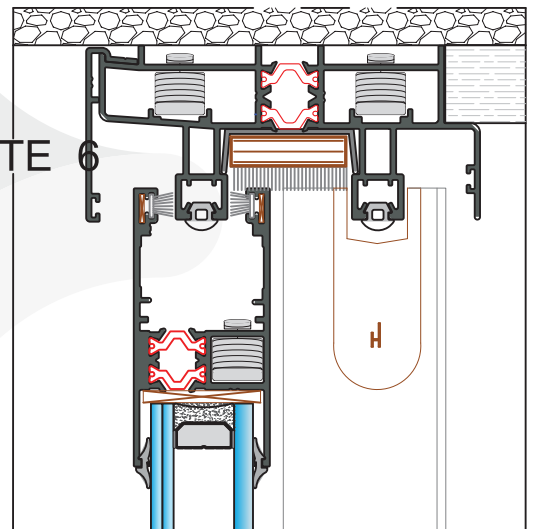

CORTE 7

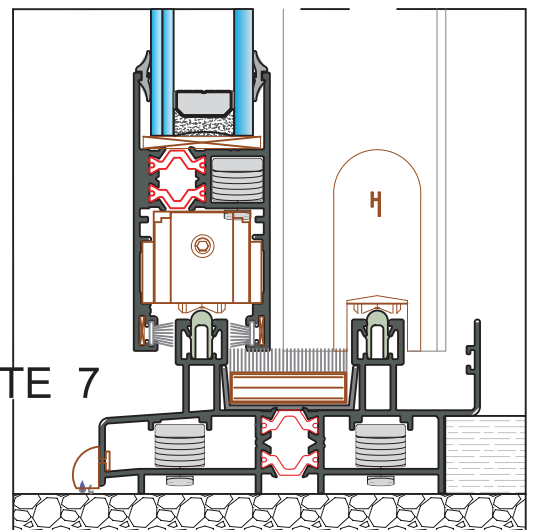

Sem
Escala

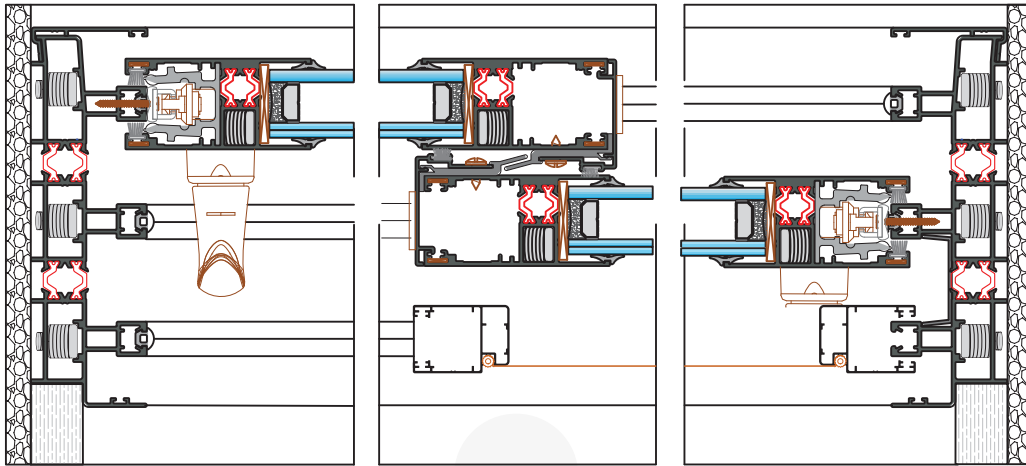

CORTE 13

CORTE 14

CORTE 15

Janela / Sacada correr 2 folhas Tri Rail
+ Rede Mosquiteira

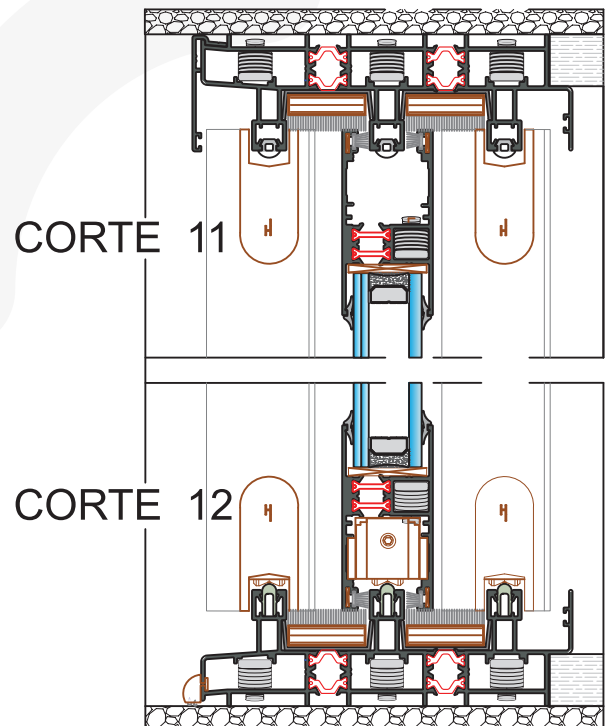
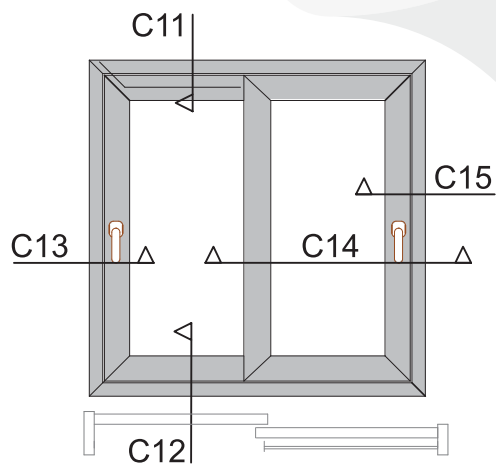

CORTE 11

CORTE 12

Sem
Escala

Janela correr 2 folhas com rede mosquiteira

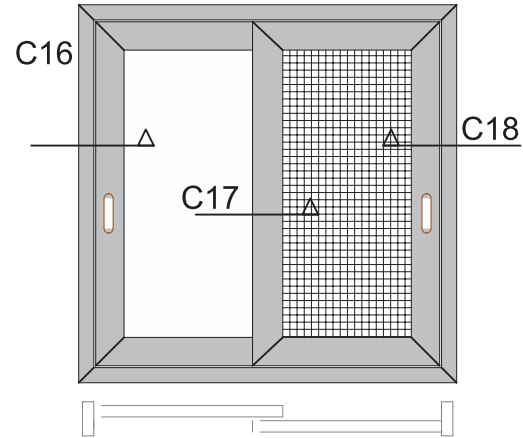
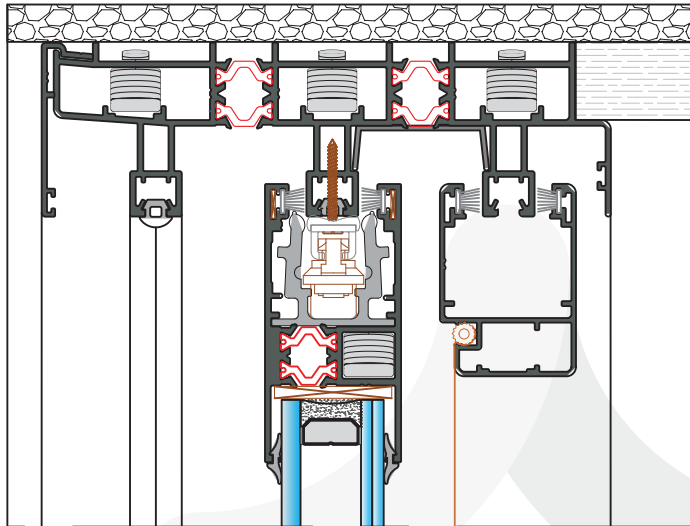

CORTE 18

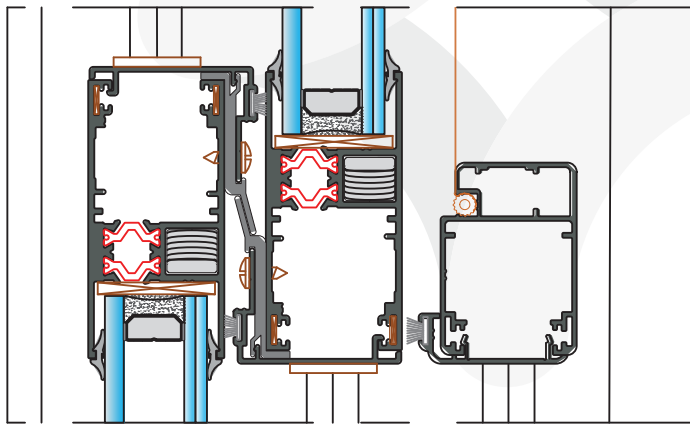

CORTE 17

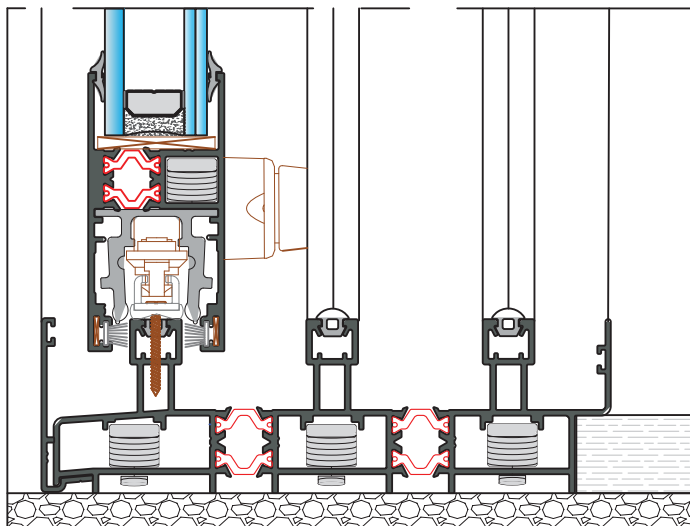

CORTE 16

Escala
1/2

Janela / Sacada correr 2 folhas

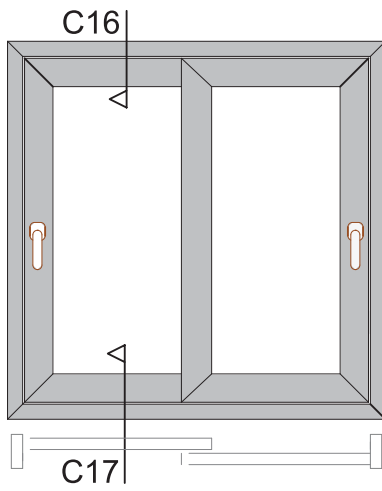

CORTE 16

CORTE 17

Escala
1/2

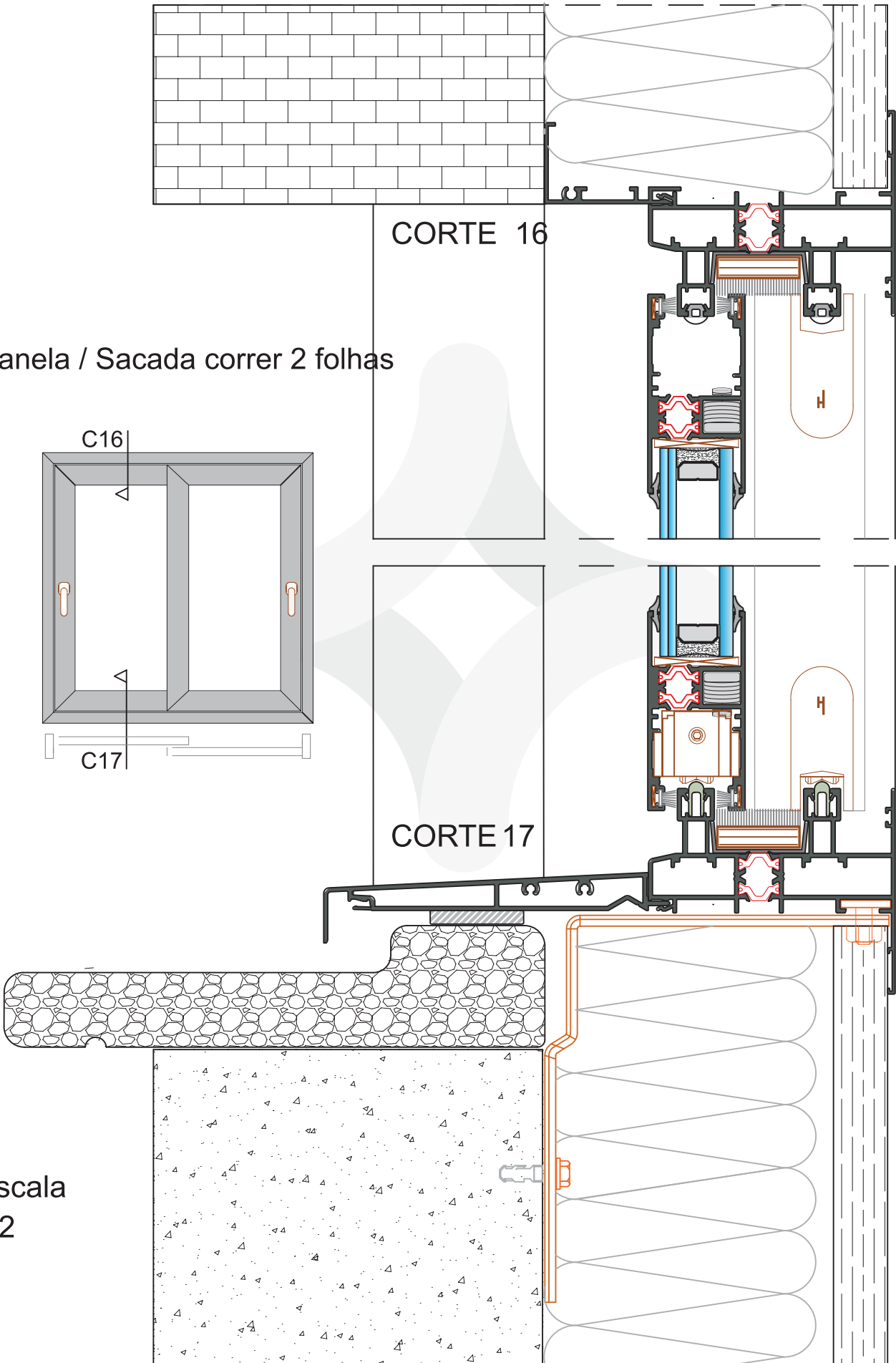

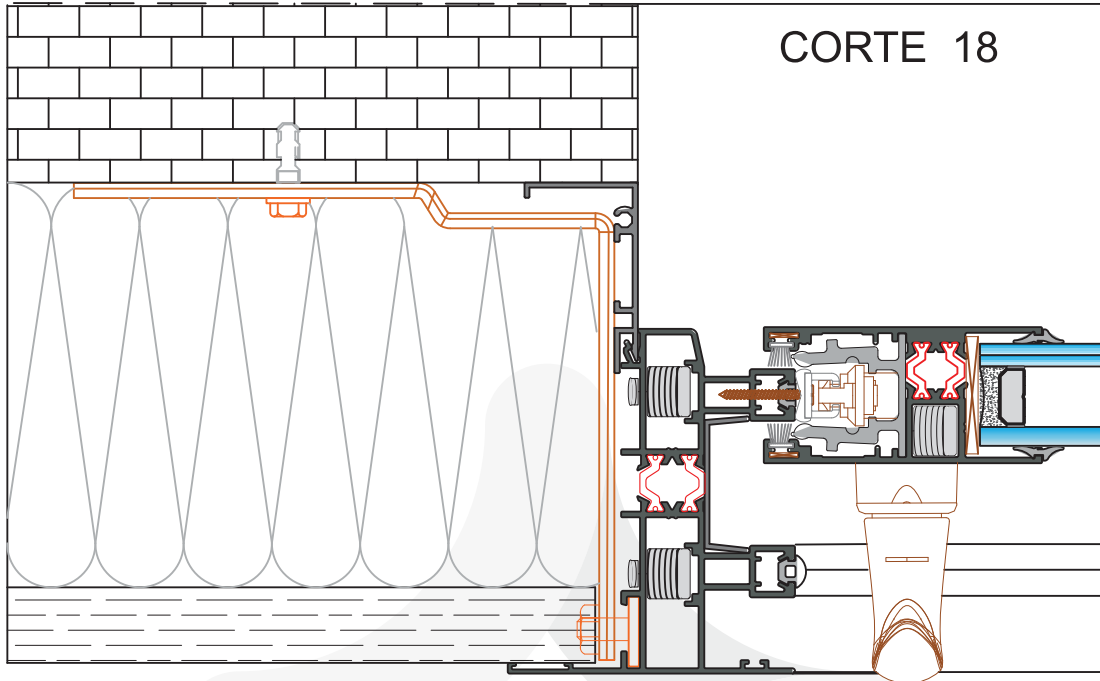

Janela / Sacada correr 2 folhas

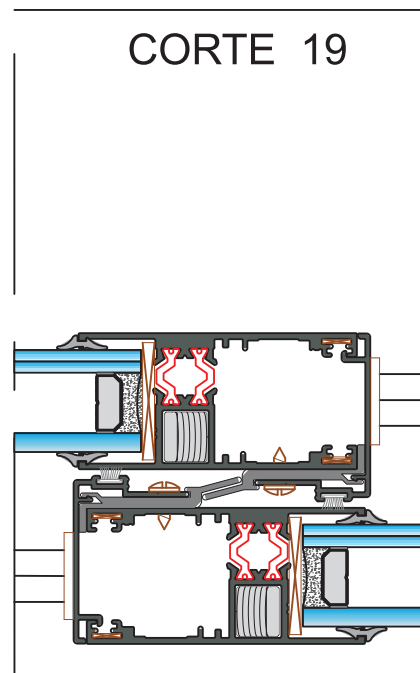
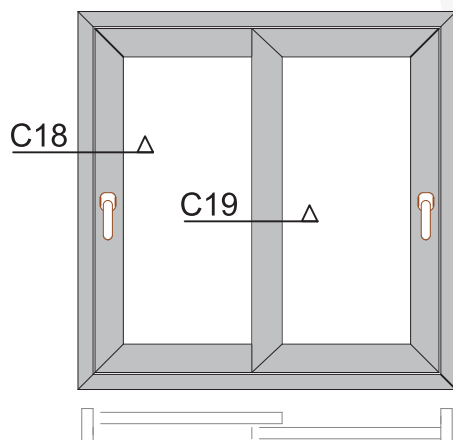

Janela / Sacada correr 4 folhas

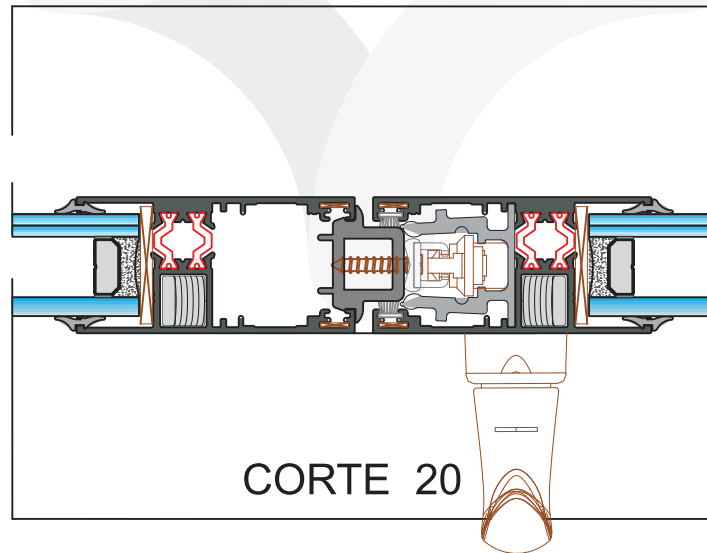
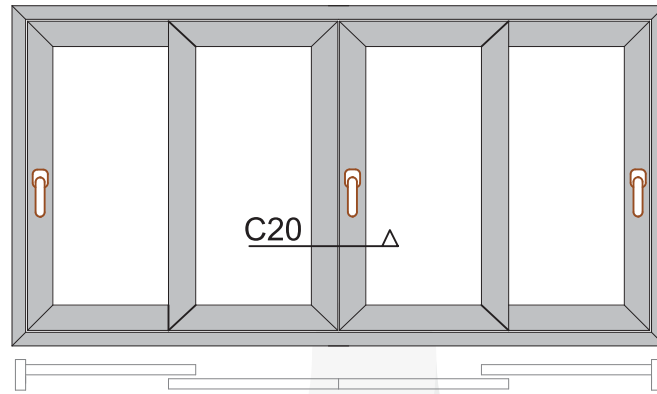

Janela / Sacada correr 1 folha (Galandage)

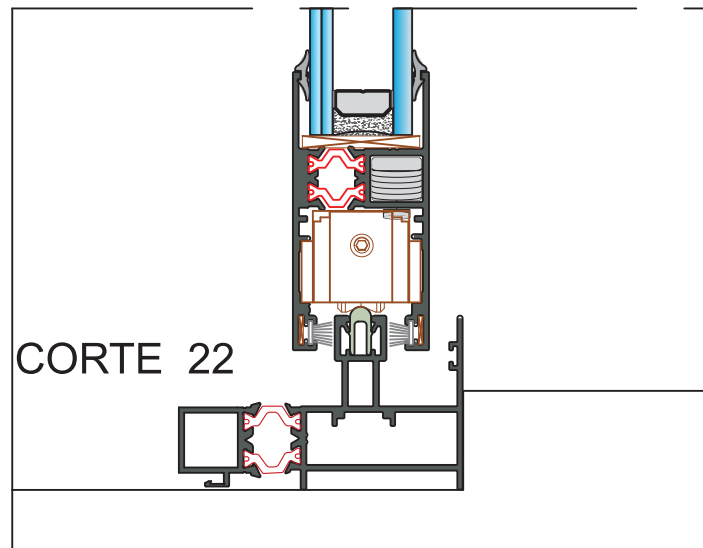
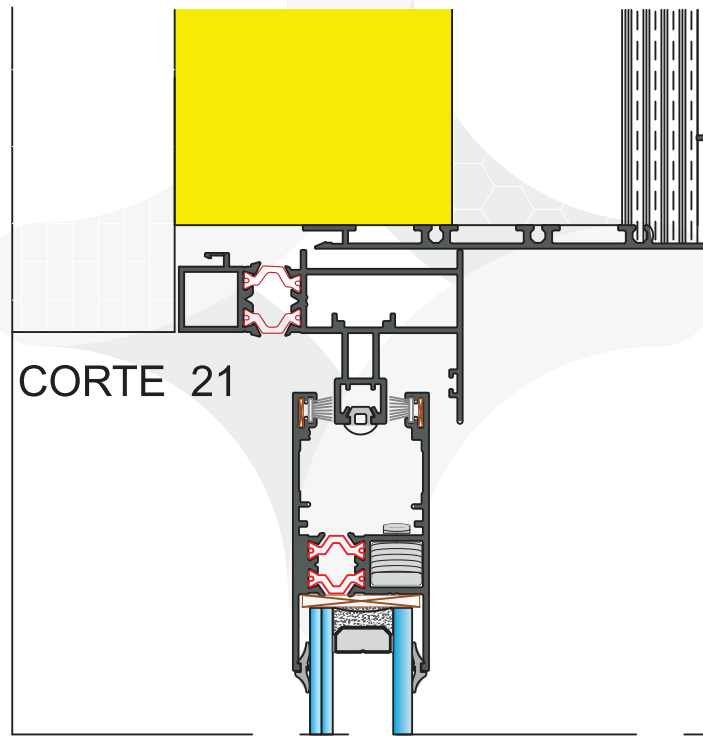
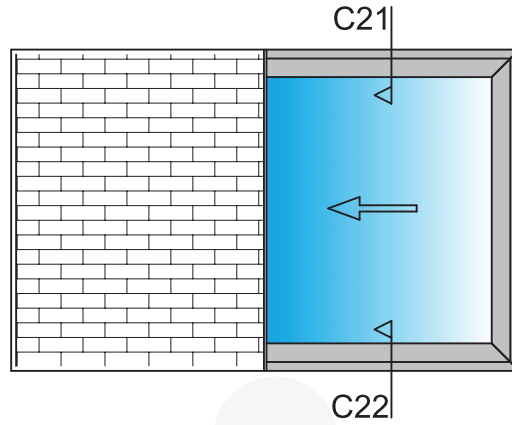

Escala
1/2

Janela / Sacada correr 1 folha (Galandage)

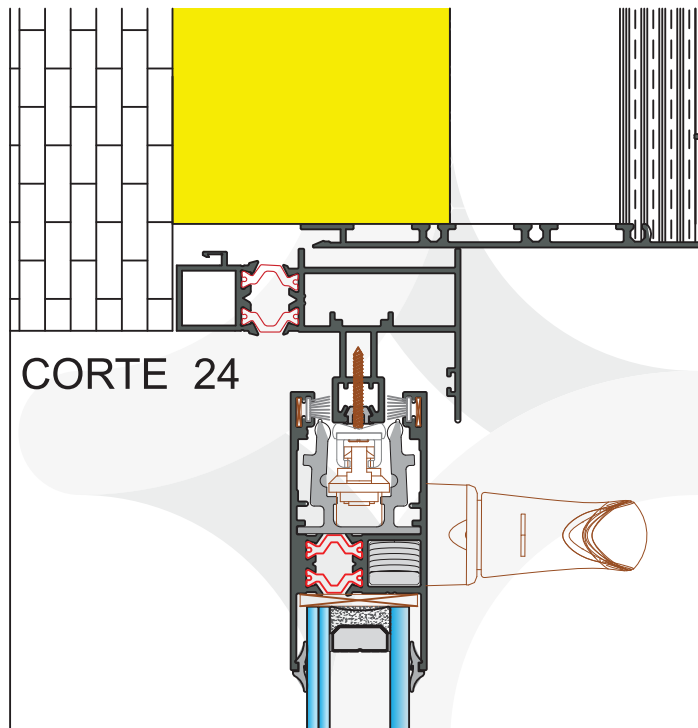
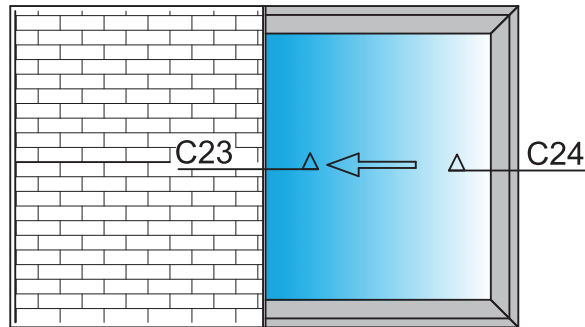

PD04.28

CORTE 23

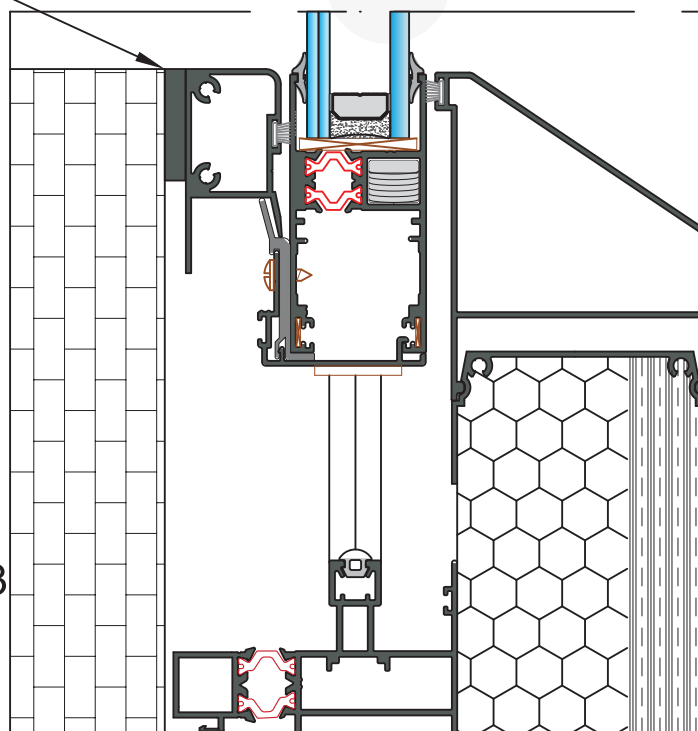

Escala
1/2

Janela / Sacada correr 2 folha (Galandage)

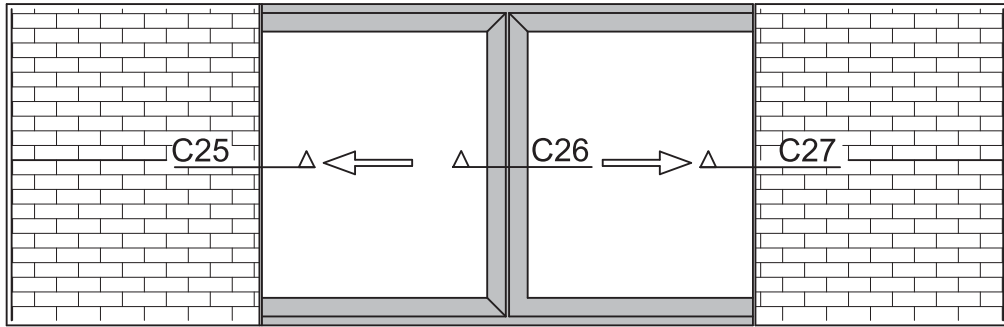

CORTE 25

PD04.28

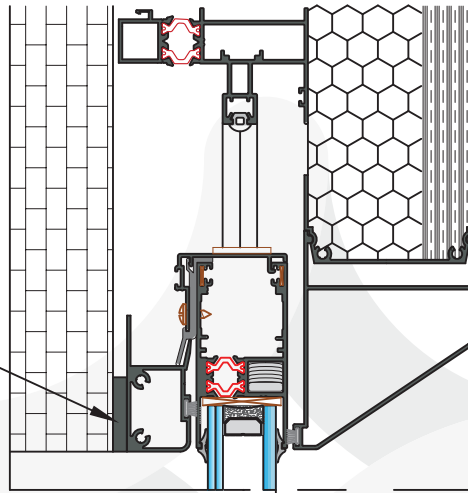

CORTE 26

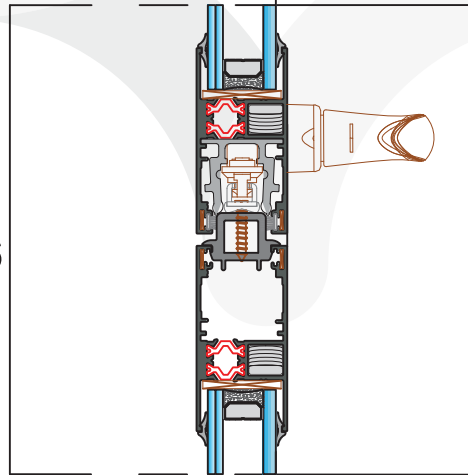

PD04.28

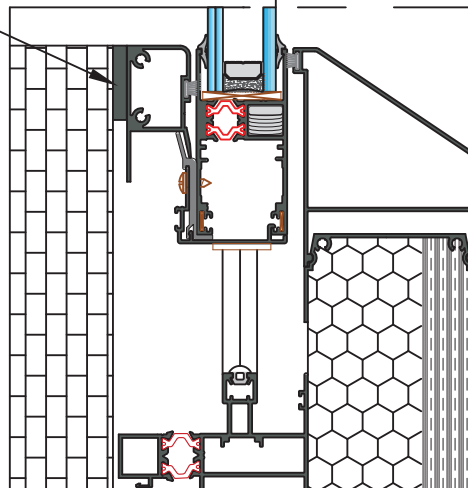

Escala
1/3

CORTE 27

Janela / Sacada correr 1 folha (Galandage)

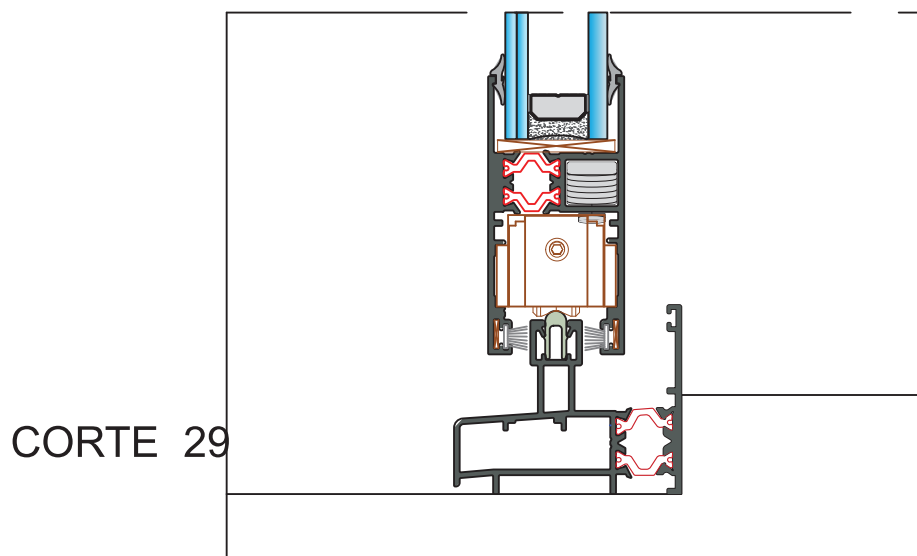
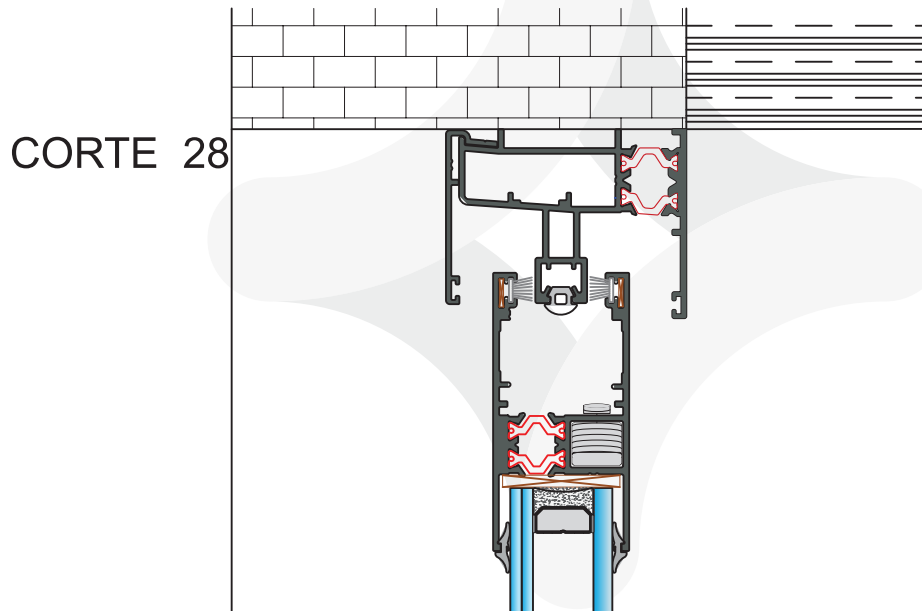
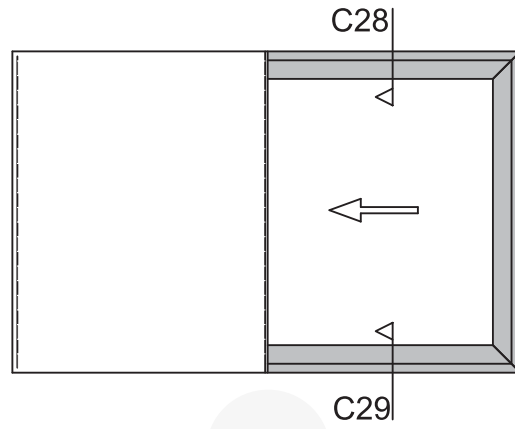

Janela / Sacada correr 1 folha (Galandage)

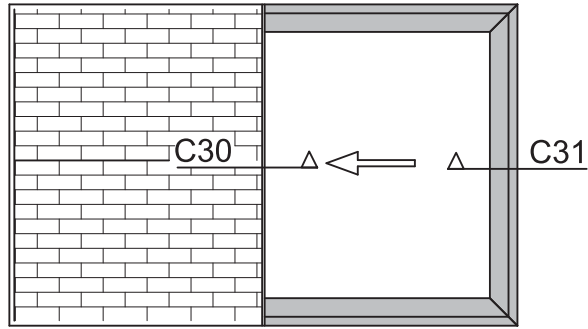

CORTE 31

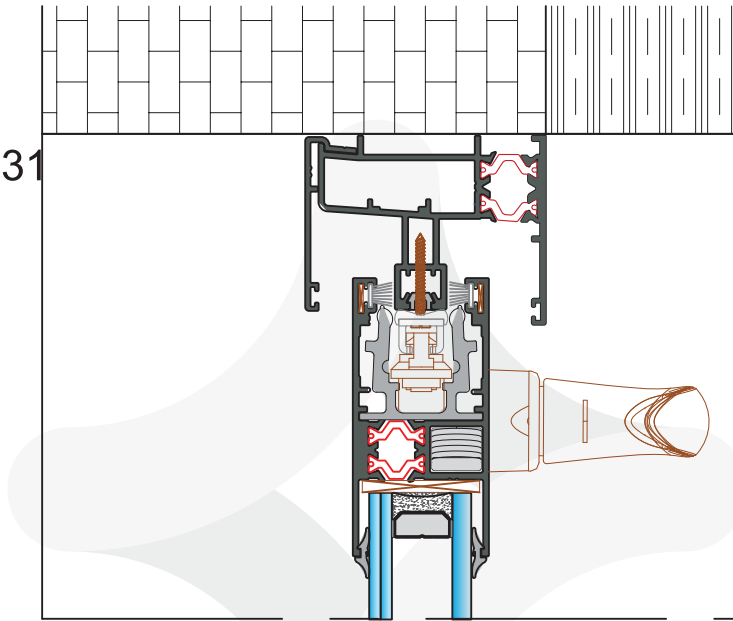

CORTE 30

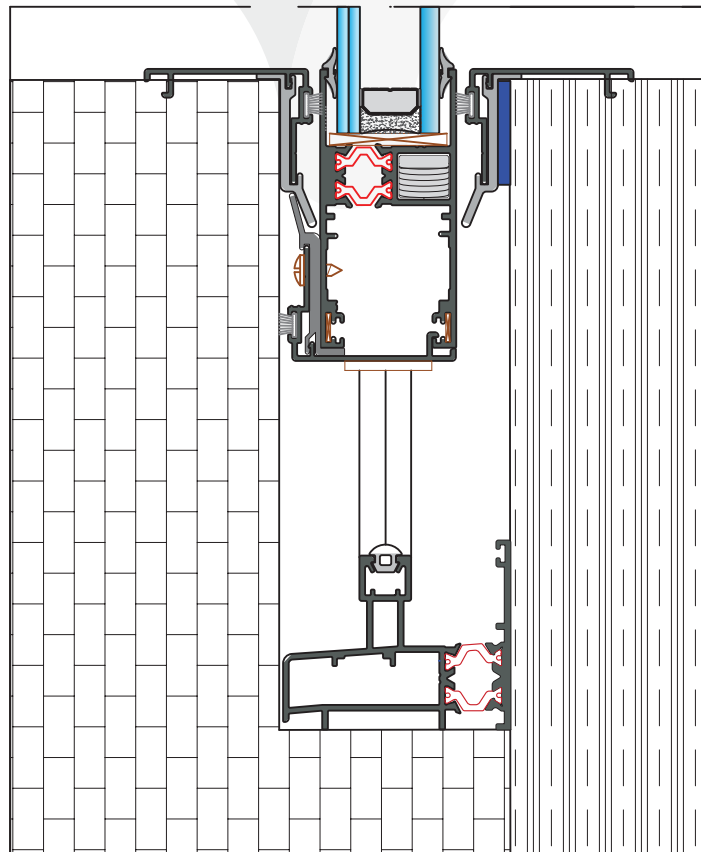

Escala
1/2

Janela / Sacada correr 2 folha (Galandage)

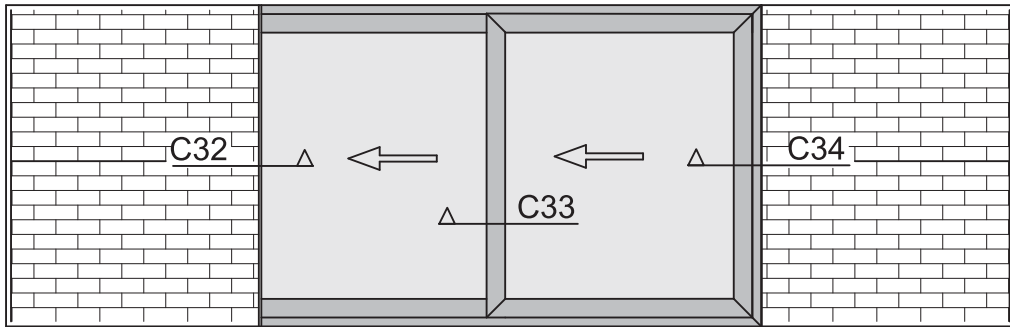

CORTE 34

CORTE 33

CORTE 32

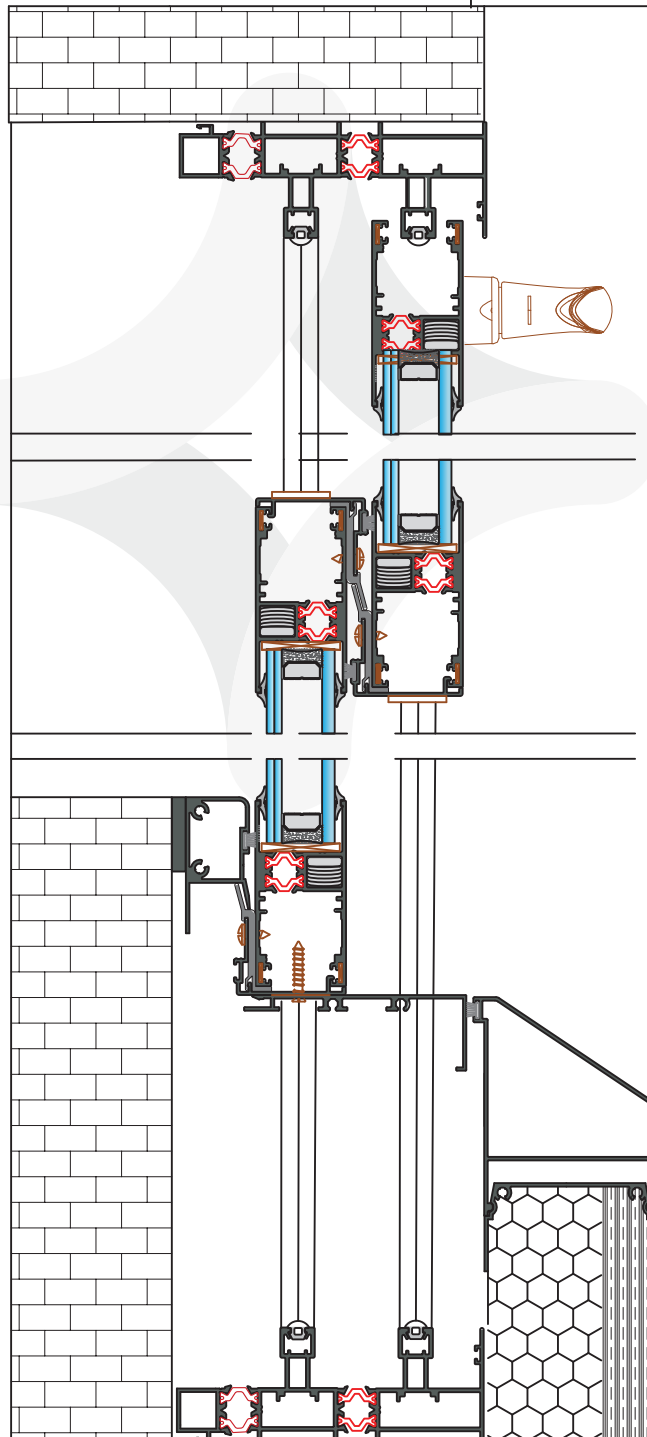

Escala
1/3

Janela / Sacada correr 2 folha (Galandage)

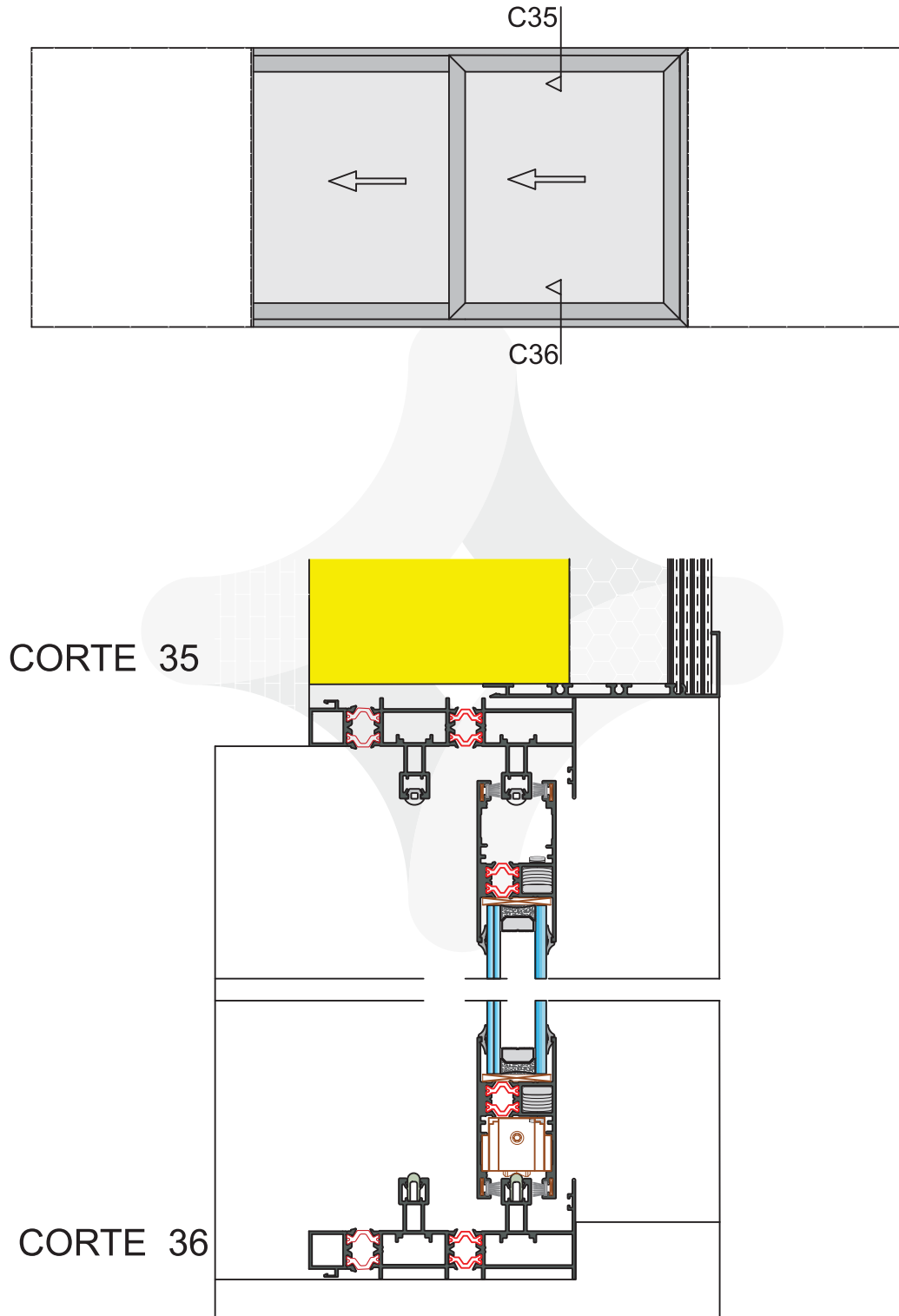



Imagem	Ref.	Descrição	Horizontal			Vertical		
			Corte	Quant.	Medida	Corte	Quant.	Medida
	PCH.02	Aro fixo		2	L		2	H
	PCH.21	Aro móvel porta		4	L/2		4	H - 72
	PCH.22	Engate central					2	H - 72
	PCH.23	Perfil remate		1	L		2	H
	PI26.27	Perfil guia		2	L - 90			
	2041033	Perfil U		2	L		2	H
	2041034	Engate central PVC					2	H - 72



Ref.	Descrição	Horizontal		Vertical	
		Quant.	Medida	Quant.	Medida
R 01.317	Pelucia 6,5 x 5			2	H
R 01.333	Pelucia 6,5 x 9	4	L	4	H
R 60.047	Vedante tapa canal	2	L	4	H

Ref.	Descrição	Quant.
R 03.014	Esquadro injetado 14x12	16
R 03.083	Esquadro alinhamento inox PCH	16
R 03.024	Esquadro de alinhamento Inox	4
R 10.038	Goteira c/ válvula série de corre	2
R 08.084	Batente sistemas de correr	1
	Kit PCH *	1
	Ferragem *	2

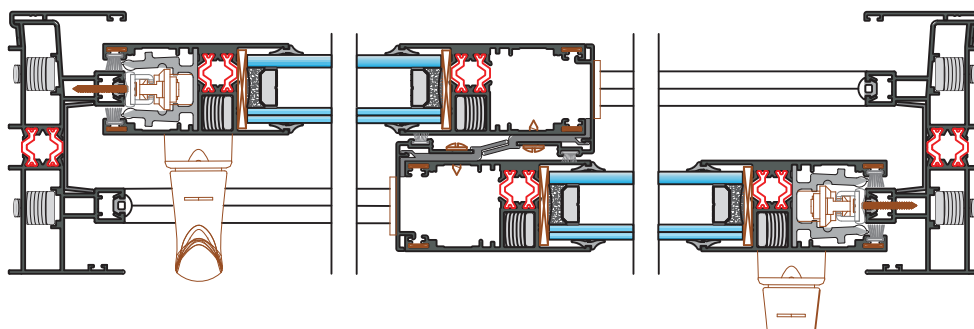
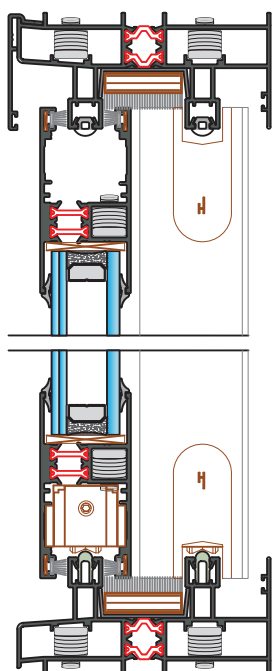
Janela / sacada de correr 2 folhas

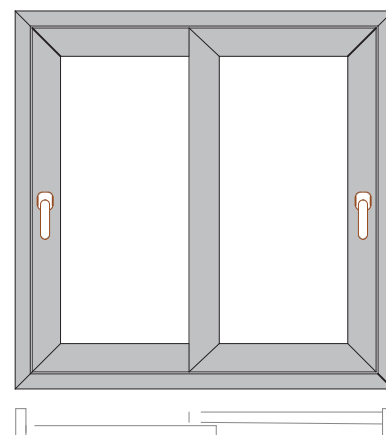

Estas medidas de corte são de carácter informativo



Imagem	Ref.	Descrição	Horizontal			Vertical		
			Corte	Quant.	Medida	Corte	Quant.	Medida
	PCH.02	Aro fixo		2	L		2	H
	PCH.21	Aro móvel porta		6	L + 73 / 3		6	H - 72
	PCH.22	Engate central					4	H - 72
	PCH.23	Perfil remate		1	L		2	H
	PI26.27	Perfil guia		2	L - 90			
	2041033	Perfil U		2	L		2	H
	2041034	Engate central PVC					4	H - 72



Ref.	Descrição	Horizontal		Vertical	
		Quant.	Medida	Quant.	Medida
R 01.317	Pelucia 6,5 x 5			4	H
R 01.333	Pelucia 6,5 x 9	4	L	4	H
R 60.047	Vedante tapa canal	2	L	4	H

Ref.	Descrição	Quant.
R 03.014	Esquadro injetado 14x12	20
R 03.083	Esquadro alinhamento inox PCH	24
R 03.024	Esquadro de alinhamento Inox	4
R 10.038	Goteira c/ válvula série de correr	2
R 08.084	Batente sistemas de correr	2
	Kit PCH *	2
	Ferragem *	2

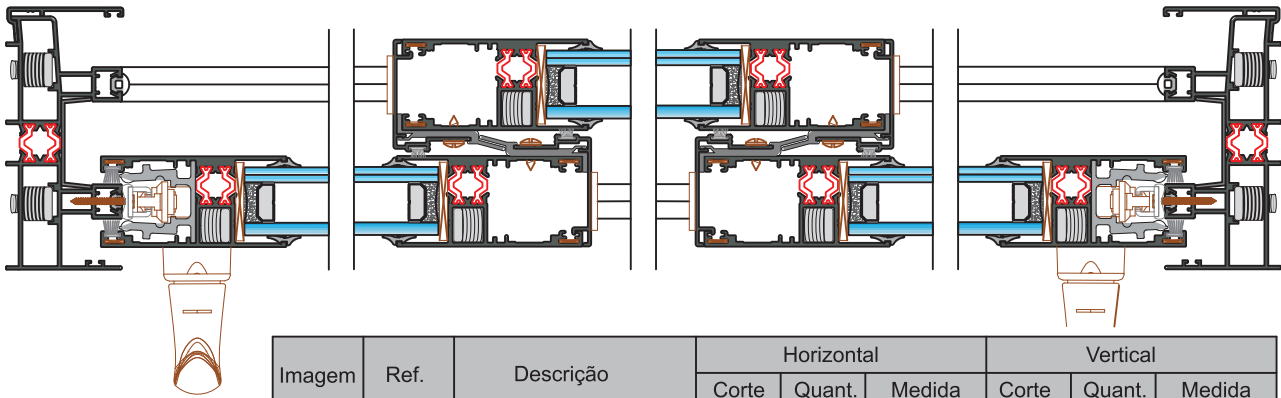
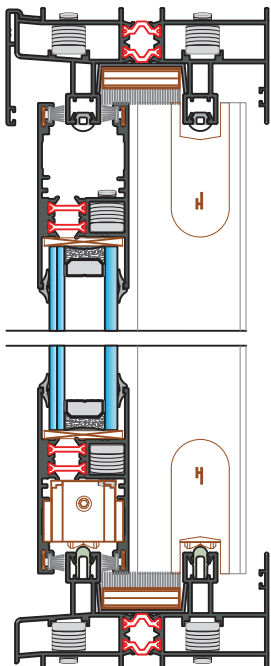
Janela / sacada de correr 3 folhas

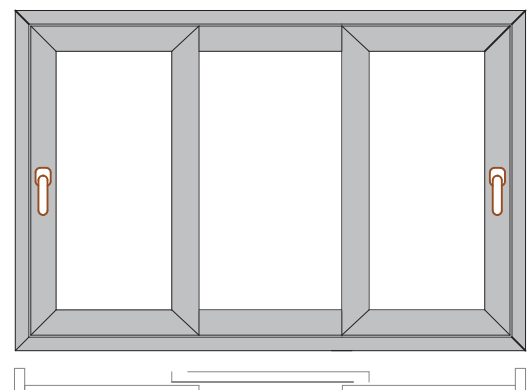



Imagem	Ref.	Descrição	Horizontal			Vertical		
			Corte	Quant.	Medida	Corte	Quant.	Medida
	PCH.02	Aro fixo		2	L		2	H
	PCH.21	Aro móvel porta		8	$L + 70 / 4$		8	$H - 72$
	PCH.22	Engate central					4	$H - 72$
	PCH.23	Perfil remate		1	L		2	H
	PI26.27	Perfil guia		2	$L - 90$			
	2041033	Perfil U		2	L		2	H
	2041034	Engate central PVC					4	$H - 72$
	2041036	Perfil 4 folhas					1	$H - 72$



Ref.	Descrição	Horizontal		Vertical	
		Quant.	Medida	Quant.	Medida
R 01.317	Pelucia 6,5 x 5			4	H
R 01.333	Pelucia 6,5 x 9	4	L	6	H
R 60.047	Vedante tapa canal	2	L	4	H

Ref.	Descrição	Quant.
R 03.014	Esquadro injetado 14x12	24
R 03.083	Esquadro alinhamento inox PCH	32
R 03.024	Esquadro de alinhamento Inox	4
R 10.038	Goteira c/ válvula série de correr	2
R 08.084	Batente sistemas de correr	2
	Kit PCH *	2
	Ferragem *	3

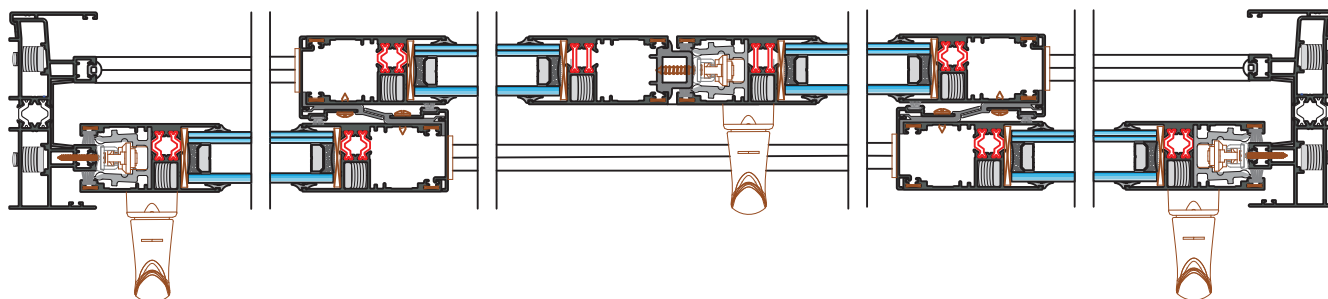
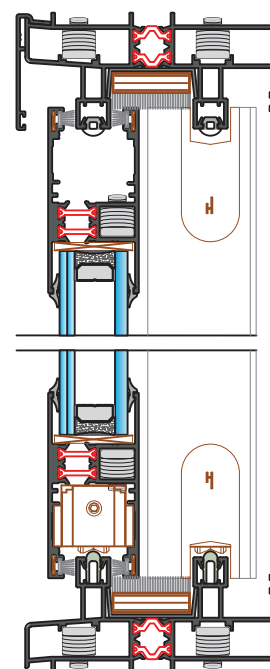
Janela / sacada de correr 4 folhas

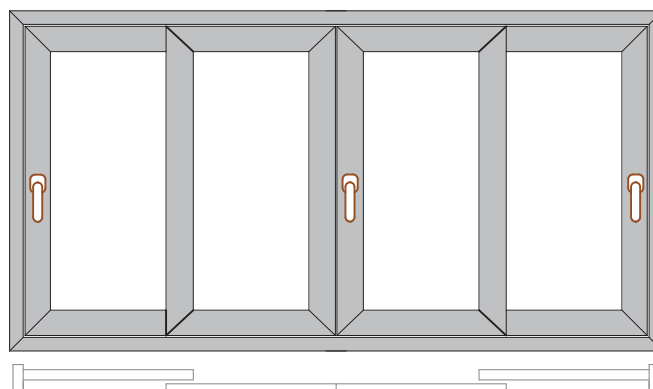



Imagem	Ref.	Descrição	Horizontal			Vertical		
			Corte	Quant.	Medida	Corte	Quant.	Medida
	PCH.04	Aro fixo Tri-Rail		2	L		2	H
	PCH.21	Aro móvel porta		6	L + 73 / 3		6	H - 72
	PCH.22	Engate central					4	H - 72
	PCH.23	Perfil remate		1	L		2	H
	PI26.27	Perfil guia		3	L - 90			
	2041033	Perfil U		4	L		4	H
	2041034	Engate central PVC					4	H - 72



Ref.	Descrição	Horizontal		Vertical	
		Quant.	Medida	Quant.	Medida
R 01.317	Pelucia 6,5 x 5			4	H
R 01.333	Pelucia 6,5 x 9	4	L	4	H
R 60.047	Vedante tapa canal	3	L	6	H

Ref.	Descrição	Quant.
R 03.014	Esquadro injetado 14x12	24
R 03.083	Esquadro alinhamento inox PCH	24
R 03.024	Esquadro de alinhamento Inox	4
R 10.038	Goteira c/ válvula série de correr	2
R 08.084	Batente sistemas de correr	2
	Kit PCH *	2
	Ferragem *	2

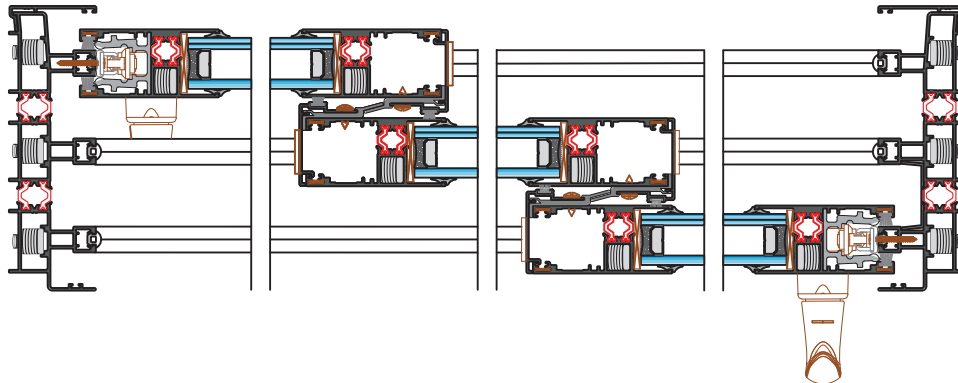
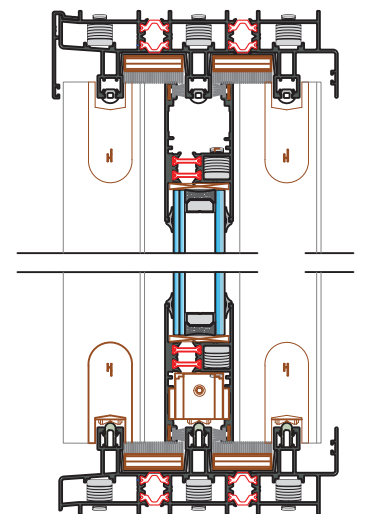
Janela / sacada de correr 3 folhas Tri Rail

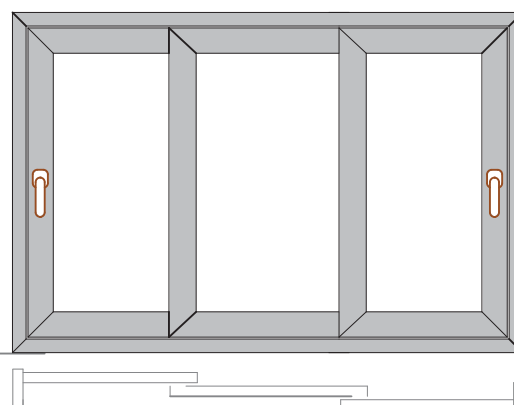

Estas medidas de corte são de carácter informativo